

# AES CABINET

## Quick Start Guide

FOR INTEGRATION WITH APPROVED HYBRID INVERTERS

This document  
is not intended  
as a replacement  
for the manual.



Specifications	CAB-106	CAB-160	CAB-210	CAB-266	CAB-318	CAB-372	CAB-426
Nominal Voltage	332.8 V	499.2 V	665.6 V	832 V	998.4 V	1,164 V	1,331.2 V
Usable Energy Capacity	104 kWh	157 kWh	209 kWh	261 kWh	313 kWh	366 kWh	418 kWh
Nominal Cell Voltage	332.8 V	499.2 V	665.6 V	832 V	998.4 V	1,164.8 V	1,331.2 V
Voltage Range	312-358.8 V	468-538.2 V	624-717.6 V	780-897 V	936-1,076.4 V	1,092-1,255.8 V	1,248-1,435.2 V
Usable Cell Capacity	314 Ah						
Continuous Current	157 A						
Nominal Cell Capacity	320 Ah						
Weight	1,770 kg (3,900 lb)	2,130 kg (4,700 lb)	2,490 kg (5,490 lb)	2,850 kg (6,285 lb)	3,190 kg (7,050 lb)	3,570 kg (7,875 lb)	3,930 kg (8,675 lb)

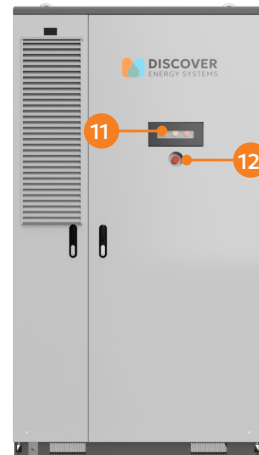
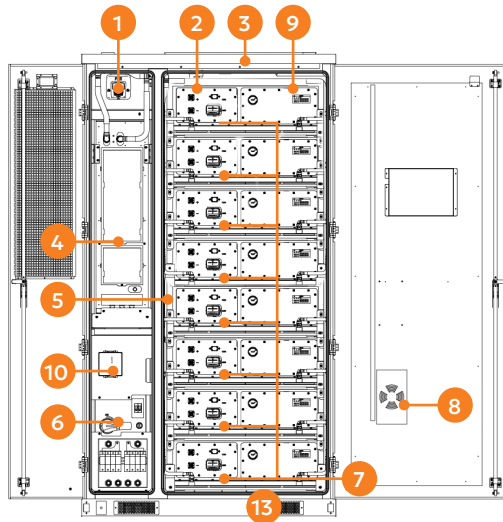

- |                                    |  |                                       |
|------------------------------------|--|---------------------------------------|
| 1. Audible and Visual Fire Alarms  | 6. High Voltage Box (HV Box)               | 10. LYNK II Gateway                   |
| 2. Heat and Smoke Detector         | 7. Manual Service Disconnect (MSD)         | 11. LED Indicators                    |
| 3. Passive Deflagration Vent       | 8. Dehumidifier                            | 12. E-Stop                            |
| 4. Thermal Management System (TMS) | 9. Cabinet Aerosol Fire Suppression Device | 13. Flood Detector / Drain Indicators |
| 5. Battery Packs (up to 8)         |  |                                       |

## INSTALLATION

### Minimum Clearance

- Front door to system boundary: 900 mm (3 ft)
- Back-to-back: 500 mm (20 in)
- Side-by-side: 0 mm
- Side to system boundary: 900 mm (3 ft)

**NOTE:** Verify airflow and service access requirements with the local authority having jurisdiction.

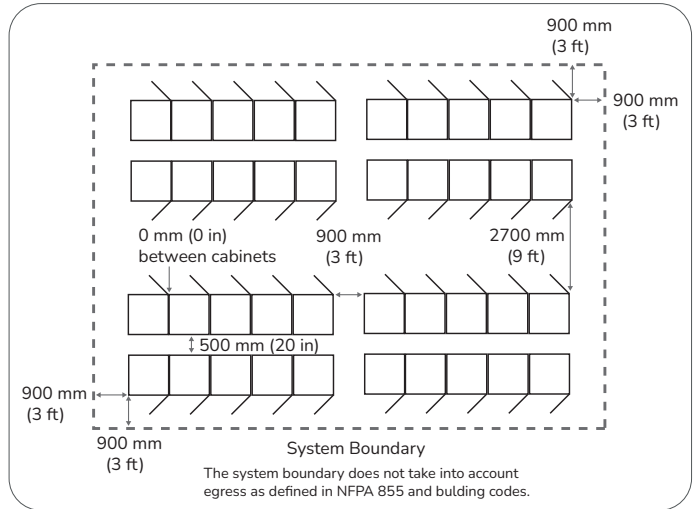

### Hoisting into Position

- Connect the crane hook to all 4 lifting eyelits\*, 900 mm (3 ft) or more above the cabinet.
- Keep lift angle less than 10 degrees.
- Use spreader bar for overhead lift.
- Use chains/straps rated at least 500 kg (1,100 lb) greater than the cabinet.
- Lower slowly and align with conduit entries.

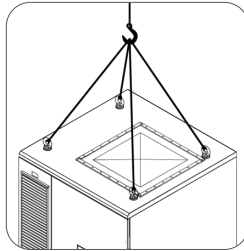

\* Lifting eyelits shipped inside the cabinet.

Conduit entry points and access zone. Side conduit entry also possible.

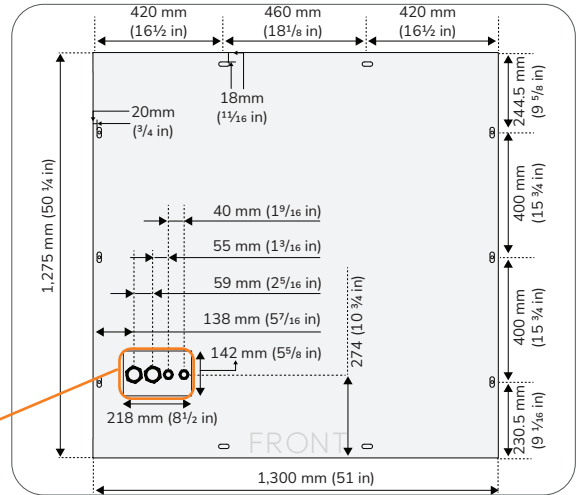

## WIRE ROUTING

To access the wiring area, remove the bottom wire shield and/or DC Distribution Panel.

Route wiring through the foundation conduit and into the battery cabinet through the removable plate.

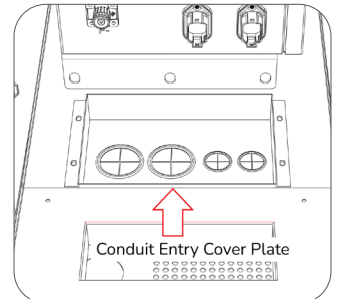
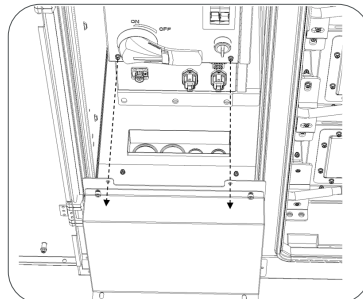

## AC Auxiliary Connection

- Minimum #10 AWG cable (30 A breaker).
  - Connect to 200-275 Vac source (single-phase).
- Connect AUX AC wiring harness to source power inside the AC Junction Box.

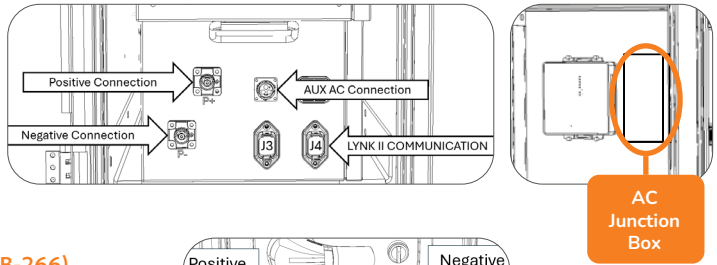

## DC Fuse Box (CAB-106, CAB-160, CAB-210 & CAB-266)

- Follow inverter/PCS manual for conductor size.
- Plug in power cables P+ (red/orange) and P (black) to HV Box.
- Land inverter conductors to fuses.
- Default fuse size: 70 Adc

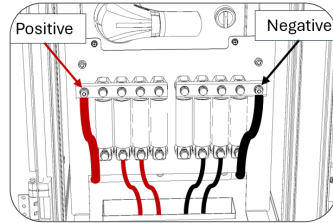

## COMMUNICATION

- Connect RJ45 cable from HV Box J3/J4 port to LYNK II (LYNK port).
- Connect RJ45 cable from LYNK II (CAN port) to inverter's BMS CAN port.
- Connect RJ45 cable from LYNK II Ethernet port to internet source for LYNK Cloud monitoring

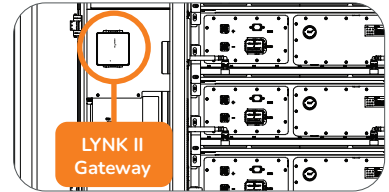

**NOTE:** When configured, loss of communication can trigger automatic shutdown, offering rapid shutdown compliance.

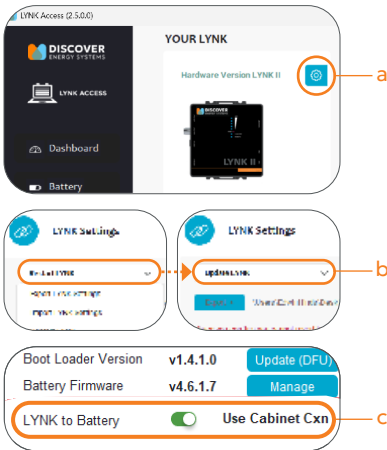

## Install and Configure a LYNK II Gateway

1. Connect the LYNK II Gateway to a computer using the USB cable.
2. Launch LYNK ACCESS 2.5.0 or later and update the LYNK II firmware to version 2.5.0 or later.
3. Configure closed-loop communication on LYNK ACCESS.
  - a. In the LYNK tile, click on the blue gear icon.
  - b. In the drop down menu, select **Update LYNK**
  - c. Toggle **LYNK to Battery** from Use AEBus to **Use Cabinet Cxn**. Click **Confirm**.

**NOTE:** The **Closed Loop Protocol** will automatically be set to **HV-BMS**.

## Install and Configure Two LYNK II Devices and One AES Cabinet

1. Connect your computer to the first LYNK II Gateway and in the LYNK ACCESS Cabinet Settings, set it as **Primary**, to control monitoring and closed-loop communication with the inverter.
2. Connect to the second LYNK II Gateway and in LYNK ACCESS, set it as **Secondary**, to monitor and communicate with the inverter.

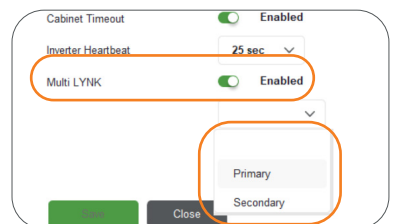

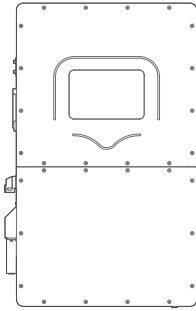

### Inverter Configuration

- LYNK II uses the Pylon HV protocol, commonly used by inverters.
- Connect a CAT6 or higher cable between the inverter's BMS/Battery port and the LYNK II CAN port.

For configuration details, refer to the corresponding inverter integration guide.



SCAN THE CODE  
OR CLICK  
[THIS LINK.](#)

## INSTALL MSDs

1. With its handle up, insert the MSD in the correct orientation into the battery pack's receptacle, push in until it locks into place.
2. Push in the safety lock. Gently pull on the MSD to confirm it is secured.

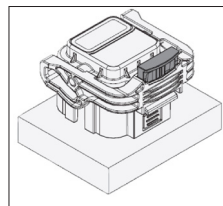
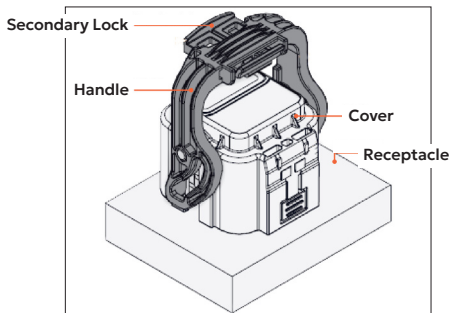

Locked (Handle is Down)

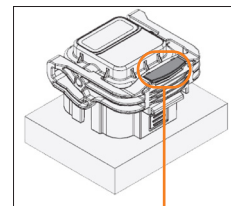

Locked (Safety Lock is Down)

## START UP PROCEDURE

1. Inspect the cabinet and wiring.
2. Re-attach all safety covers.
3. Confirm E-stop is disengaged.
4. Rotate the DC Disconnect to ON.
5. Turn ON the AC Auxiliary breaker.
6. If there is no AC power, turn UPS switch to the right.

During the startup sequence, the LED on the AES Cabinet flashes green.

Once the battery is operational and active, the LED turns solid green.

## POWER DOWN PROCEDURE

1. Eliminate inverter load, set it to standby.
2. Press the E-Stop button on cabinet.
3. Turn OFF the AC Auxiliary breaker.
4. Turn OFF the UPS by turning switch to the left.
5. Rotate the DC Disconnect to OFF.

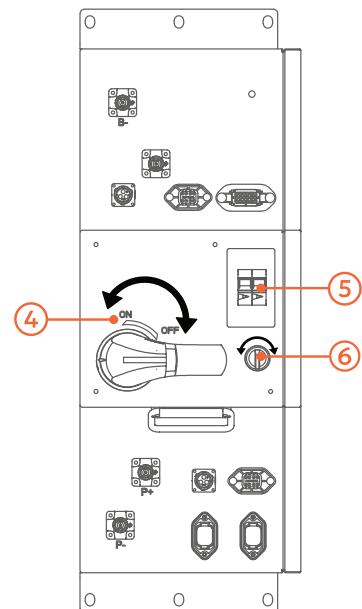

## TROUBLESHOOTING

Identified Problem	Plausible fault	Corrective Action
<b>Pre-charge fault</b>	Steps in the startup procedure were out of order.	<ul style="list-style-type: none"> <li>Start up the AES Cabinet as specified.</li> <li>Perform the <b>START UP PROCEDURE</b> as per this Quick Start Guide.</li> </ul>
<b>Battery door is open fault</b>	Cabinet door is open.	<ul style="list-style-type: none"> <li>Close the battery compartment door.</li> </ul>
	Door sensor bracket bent or not at the correct angle.	<ul style="list-style-type: none"> <li>Inspect the mounting bracket and ensure it sits at a true 90° angle, so the switch fully depresses when the door is closed.</li> </ul>
<b>Closed-loop communication is not working</b>	The AES Cabinet, through the LYNK II, is not communicating with the inverter.	<ul style="list-style-type: none"> <li>Verify each cable is connected securely to the correct port. If using a manually crimped cable, it may be mis-wired or damaged.</li> <li>Ensure LYNK II and inverter are configured correctly.</li> </ul>
<b>Amber light is flashing (this is just a warning)</b>	These are self-correcting, low-priority warnings.	<ul style="list-style-type: none"> <li>Read the Faults and Warnings Section in the Operation and Maintenance Manual to identify the cause and perform the corrective action.</li> <li>Connect your computer to LYNK II and start LYNK ACCESS software to identify the warnings.</li> </ul>
<b>Amber light is solid</b>	Manual intervention required.	<ul style="list-style-type: none"> <li>Connect your computer to LYNK II and start LYNK ACCESS software to identify the fault.</li> <li>Refer to the Faults and Warnings section in the Operation and Maintenance Manual to identify faults.</li> <li>Critical faults require restarting the battery after identifying and resolving the issue.</li> </ul>
<b>Battery has shut down</b>	Immediate attention is required.	<ul style="list-style-type: none"> <li>A critical fault is in effect and manual or power cycle reset is required.</li> <li>Refer to the Faults and Warnings section in the Operation and Maintenance Manual to identify the cause and perform the corrective action.</li> </ul>
<b>Temperature protection</b>	Extreme temperatures, air circulation, or an issue with the thermal management system.	<ul style="list-style-type: none"> <li>Confirm environmental conditions are within acceptable ranges.</li> <li>Check and clean the vents, including the TMS door vent screen. Ensure there is airflow.</li> <li>Clean fans and replace if they have failed.</li> <li>Confirm operation of the TMS and other parts of the cooling system.</li> </ul>
<b>Cannot connect to LYNK Cloud</b>	Firewall or other communication issue preventing connection with the server.	<ul style="list-style-type: none"> <li>Verify that the network allows outbound internet access and that the LYNK II can obtain its security certificate.</li> </ul>

